



CODE CHANGE PROPOSAL FORM

(Must be submitted electronically)

Author/requestor: Karen Gridley

Date: 7/1/2024

Email address: karen.gridley@state.mn.us

Model Code: IBC

Telephone number: 652-284-5877

Code or Rule Section: 1108.5 & 1108.6

Firm/Association affiliation, if any: CCLD

Topic of proposal: Assisted Living unit types

Code or rule section to be changed: IBC 1108.5 – 1108.6.3 with MN 1341 Amendments

Intended for Technical Advisory Group (“TAG”): 1341

General Information

Yes **No**

- | | | |
|--|-------------------------------------|-------------------------------------|
| A. Is the proposed change unique to the State of Minnesota? | <input checked="" type="checkbox"/> | <input type="checkbox"/> |
| B. Is the proposed change required due to climatic conditions of Minnesota? | <input type="checkbox"/> | <input checked="" type="checkbox"/> |
| C. Will the proposed change encourage more uniform enforcement? | <input checked="" type="checkbox"/> | <input type="checkbox"/> |
| D. Will the proposed change remedy a problem? | <input checked="" type="checkbox"/> | <input type="checkbox"/> |
| E. Does the proposal delete a current Minnesota Rule, chapter amendment? | <input type="checkbox"/> | <input checked="" type="checkbox"/> |
| F. Would this proposed change be appropriate through the ICC code development process? | <input type="checkbox"/> | <input checked="" type="checkbox"/> |

Proposed Language

1. The proposed code change is meant to:

change language contained the model code book? If so, list section(s).
See proposed change language for all the sections.

change language contained in an existing amendment in Minnesota Rule? If so, list Rule part(s).

delete language contained in the model code book? If so, list section(s).

delete language contained in an existing amendment in Minnesota Rule? If so, list Rule part(s).

add new language that is not found in the model code book or in Minnesota Rule.

2. Is this proposed code change required by Minnesota Statute? If so, please provide the citation.

Yes. Due to Statute 326B.103 for State Licensed Assisted Living facilities. And due to MN Rules part 4658.41.50 for I-2 Nursing homes.

3. Provide *specific* language you would like to see changed. Indicate proposed new words with underlining and ~~strikethrough~~ words proposed for deletion. Include the entire code (sub) section or rule subpart that contains your proposed changes.

1108.5 Group I. *Accessible units* and *Type B units* shall be provided in Group I occupancies in accordance with Sections 1108.5.1 to 1108.5.5. *Dwelling units* and *sleeping units* intended to be used by guests in Groups I-1 and I-2 occupancies providing *Accessible units* or *Type B units* shall comply with Sections 1107.6.1.1, 1107.6.1.3, and 1107.6.1.5.

1108.5.1 Group I-1. ~~In Group I-1 occupancies not licensed by the Department of Health,~~ *Accessible units* and *Type B units* shall be provided in accordance with Sections 1108.5.1.1 through 1108.5.1.3. *Group I-1 boarding care facilities* licensed by the Department of Health shall be provided in accordance with Section 1108.5.1.4.

1108.5.1.1 Accessible units. In Group I-1, Condition 1, at least 4 percent, but not less than one, of the *dwelling units* and *sleeping units* shall be *Accessible units*. Accessible dwelling units and sleeping units shall be dispersed among the various classes of units.

Exceptions:

1. Water closets shall not be required to comply with ICC A117.1 where such water closets comply with Section 1110.2.2, in not more than 50 percent of the Accessible units.
2. Roll-in-type showers shall not be required to comply with ICC A117.1 where roll-in-type showers comply with Section 1110.2.3, in not more than 50 percent of the Accessible units.

1108.5.1.2 Accessible units in Group I-1, Condition 2. In Group I-1, Condition 2, at least 10 percent, but not less than one of the dwelling units and sleeping units shall be Accessible units. Accessible dwelling units and sleeping units shall be dispersed among the various classes of units.

Exceptions:

1. Water closets shall not be required to comply with ICC A117.1 where such water closets comply with Section 1110.2.2, in not more than 50 percent of the Accessible units.
2. Roll-in-type showers shall not be required to comply with ICC A117.1 where roll-in-type showers comply with Section 1110.2.3, in not more than 50 percent of the Accessible units.

1108.5.1.3 Type B units. In structures with four or more *dwelling units* or *sleeping units* intended to be occupied as a residence, every *dwelling unit* and *sleeping unit* intended to be occupied as a residence shall be a *Type B unit*.

Exception: The number of *Type B units* is permitted to be reduced in accordance with Section 1107.7.

1108.5.1.4 Boarding care. All boarding care resident rooms and common use bathing rooms provided only for boarding care resident use shall comply with Minnesota Rules, Chapter 4660. All other rooms and spaces shall comply with the applicable provisions of this code.

~~1107.5.2~~**1108.5.2 Group I-2 nursing homes and I-2 Assisted Living With Dementia Care.** ~~Accessible units and Type B units~~ shall be provided in nursing homes of Group I-2, ~~Condition 1~~ occupancies in accordance with ~~Sections 1108.5.2.1.~~

~~1108.5.2.1~~**1108.5.2.1 Group I-2 nursing homes.** At least 10 percent but not less than one of each type of the dwelling units and sleeping units shall be Accessible units and 90 percent but not less than one of all nursing home resident rooms, and all common use toilet rooms and bathing rooms provided only for nursing home resident use, shall comply with Minnesota Rules, part 4658.4150. All other rooms and spaces shall comply with the applicable provisions of this code.

~~1107.5.3~~**1108.5.3 Group I-2 hospitals.** (no changes to this section other than re-numbering)

~~1107.5.4~~**1108.5.4 Group I-2 rehabilitation facilities.** In hospitals and rehabilitation facilities of Group I-2 occupancies that specialize in treating conditions that affect mobility, or units within either that specialize in treating conditions that affect mobility, 100 percent of the *dwelling units* and *sleeping units* shall be *Accessible units*.

Exceptions:

[1. Water closets shall not be required to comply with ICC A117.1 where such water closets comply with Section 1110.2.2, in not more than 50 percent of Accessible units.](#)

[2. Roll-in-type showers shall not be required to comply with ICC A117.1 where roll-in-type showers comply with Section 1110.2.3, in not more than 50 percent of Accessible units.](#)

1108.5.5 Group I-2 Licensed Care facilities. Licensed care facilities other than nursing homes, hospitals and rehabilitation facilities, including but not limited to supervised living facilities.

1108.5.5.1 Accessible units. In Group I-2, Condition 1, at least 4 percent, but not less than one, of the *dwelling units* and *sleeping units* shall be *Accessible units*. Accessible dwelling units and sleeping units shall be dispersed among the various classes of units.

Exceptions:

1. Water closets shall not be required to comply with ICC A117.1 where such water closets comply with Section 1110.2.2, in not more than 50 percent of the Accessible units.

2. Roll-in-type showers shall not be required to comply with ICC A117.1 where roll-in-type showers comply with Section 1110.2.3, in not more than 50 percent of the Accessible units.

1108.5.5.2 Type B units. In structures with four or more dwelling units or sleeping units intended to be occupied as a residence, every dwelling unit and sleeping unit intended to be occupied as a residence shall be a Type B unit.

Exception: The number of Type B units is permitted to be reduced in accordance with **Section 1108.7.**

1107.5.5**1108.5.6 Group I-3.** (no changes to this section other than re-numbering)

(Need to Re-number 1108.5.5 Group I-3 to 1108.5.6, and all related subsections due to adding new section 1108.5.5 Group I-2 Care facilities as a MN Amendment)

1108.6.3 Group R-3. [Accessible units and Type B units shall be provided in Group R-3 occupancies in accordance with Sections 1108.6.3.1 and 1108.6.3.2.](#) Bedrooms within [State Licensed Facilities in accordance with MN Statute Section 326B.103.](#), *congregate living facilities, dormitories, sororities, fraternities, and boarding houses* shall be counted as *sleeping units* for the purpose of determining the number of units.

Exception: The number of *Type B units* is permitted to be reduced in accordance with **Section 1108.7.**

1108.6.3.1 Accessible units. In Group R-3 [State Licensed Facilities in accordance with MN Statute Section 326B.103.](#) *congregate living facilities (transient) or boarding houses (transient)* Accessible sleeping units shall be provided in accordance with **Table 1108.6.1.1.**

Exceptions:

1. The residence of a proprietor is not required to be an *Accessible unit* or to be counted toward the total number of units.

2. *Facilities* as described in **Section 1103.2.11** are not required to provide *Accessible units*.

1108.6.3.2 Type B units. In structures with four or more *dwelling units or sleeping units intended to be occupied as a residence*, every *dwelling unit or sleeping unit intended to be occupied as a residence* shall be a *Type B unit*.

Exception: The number of *Type B units* is permitted to be reduced in accordance with **Section 1108.7.**

1108.6.4 Group R-4. (no changes proposed to this section).

4. Will this proposed code change impact other sections of a model code book or an amendment in Minnesota Rule? If so, please list the affected sections or rule parts.

Yes.

(Related Code Section referenced in 1108.6.3.1 Exception 2):

1103.2.11 Residential Group R-1 or R-3. *Buildings* of Group R-1 containing not more than five *dwelling units or sleeping units in aggregate* for rent or hire that are also occupied as the residence of the proprietor are not required to comply with this chapter. *Buildings* of Group R-3 *congregate living facilities (transient) or boarding houses (transient)* containing not more than five *sleeping units* for rent or hire that are also occupied as the residence of the proprietor are not required to comply with this chapter.

Need and Reason

1. Why is the proposed code change needed? Please provide a general explanation as well as a specific explanation for any changes to numerical values (heights, area, etc.)

The proposed change is needed in order to address the needs of persons needing assisted toileting and bathing facilities as well as to address new State Statutes for assisted living facilities regulated by MN Dept of Health.

RESEARCH

MARCH 25TH, 2019 Article

TECHNICAL TOPICS, Building Safety Journal

by Kimberly Paarlberg of ICC

Assisted is defined as help given or made available to another person. Assisted living facilities provide a much-needed service to senior citizens who may have difficulty with, or concerns about living on their own. Such facilities offer a safe place to live along with 24-hour assistance, healthcare services and activities that interest the residents. As the population of the US ages, the need for these types of facilities is increasing greatly.

The International Building Code (IBC) specifies that a percentage of assisted living, nursing homes and rehabilitation facilities offer fully Accessible units for a percentage of the rooms. This percentage increases based on the anticipated need. While allowing for individuals to maintain their independence is very important, many of the elderly residents in assisted living and nursing facilities no longer have the physical strength or stability for these options to safely work for them.

The Mayer-Rothschild Foundation has completed research that has recommendations for the ideal dimensions for grab bars and toilet spacing for assisted toileting. To allow for staff to be on either or both sides of the resident for assistance in standing, sitting or transferring, the toilet must be farther from the wall than what is required in the ICC A117.1. This research shows that lifting from the sides is safer both for the staff and the resident. This same concern for staff to be able to get to all sides of the resident also spurred different configurations for roll-in showers.

The ICC Committee on Healthcare Committee (CHC) used this research to develop successful proposals for the 2021 IBC. These Code changes have allowed for bathrooms that offer assisted toilet and bathing facilities in a portion of the patient rooms required to be Accessible units.

Figure 1: Alternate water closet.

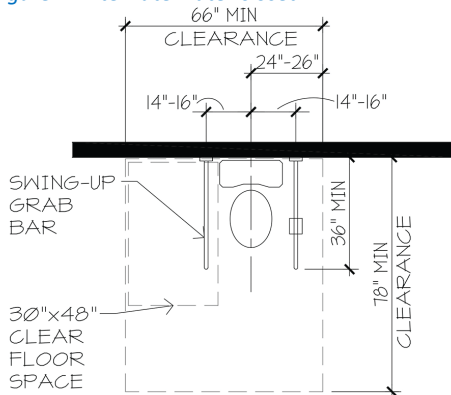

ALTERNATE WATER CLOSET

The CHC also requested that the technical provisions for assisted toileting and bathing be added to the 2021 IBC (E128-19 and E129-19). What was approved is illustrated in Figures 1, 2 3 and 4. While the CHC would have liked to propose these technical criteria to the ICC A117.1 committee, the research was not completed for consideration during the development of the 2017 edition of the ICC A117.1. The CHC does plan to propose this to the A117.1 in their next

development cycle. However, it was felt that the industry needs this critical information now, and cannot wait until the next edition of the ICC A117.1 is completed.

The intent of the assisted toileting provisions are to allow space for a side transfer from a wheelchair, however, the water closet is farther from the adjacent wall. Since a wall mounted grab bar would now be out of reach, two fold-down grab bars are required. Research has proven that the use of fold-down grab bars on both sides of the toilet is safer and easier for older adults who transfer independently. In addition, residents in care settings who need staff assistance to transfer on/off the toilet need more space between the toilet and the wall to enable a staff person (or two) to fully assist a person without risk of injury to the resident or caregiver. The additional space at the toilet would also allow for better access with many types of lifting devices.

The key part the assisted bathing option is to remove the requirement for permanently installed folding or fixed seats from a roll-in shower configuration and have grab bars on three walls. No fixed seat also allows more options for locations of the water controls. These wall mounted seats do not work well when residents are being assisted with showering. The wall mounted seats make it challenging for care-givers to access the back and one side of the resident they are bathing. Most often, if residents cannot stand for bathing, a portable, rolling chair is used and the folding seat stays folded up (but takes up space). This new configuration allows the care-giver greater access to all sides of the resident. In addition, the rolling chair is often easier to transfer to for older adults, than a wall mounted seat. This proposal also recognized alternate shower configurations that provide equal, if not better accessibility. For example, many nursing homes provide a "European" shower where two sides are open to the bathroom. This provides greater access for both resident with mobility issues as well as the care-giver. Water can be managed with shower curtains, either on a curtain track or an "L-shaped" curtain rod, however usually the entire room is designed to be a "wet room".

Figure 2: Assisted bathing roll-in shower minimum size.

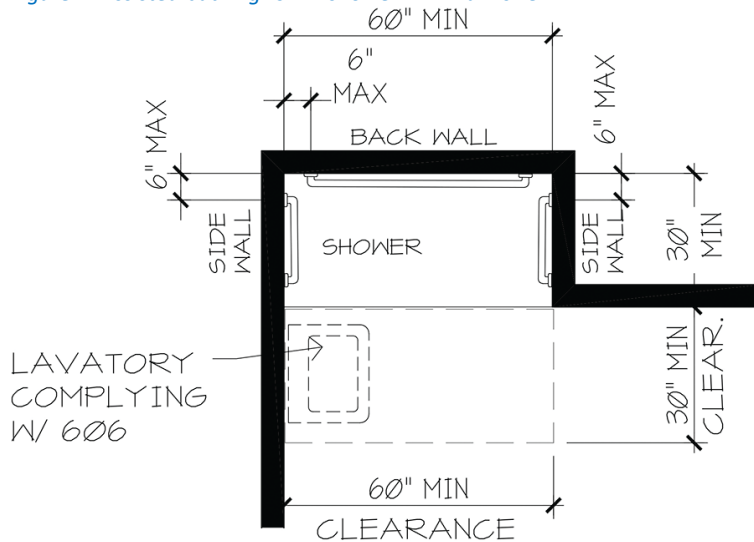

ASSISTED BATHING ROLL-IN SHOWER - MINIMUM SIZE

Figures 3 and 4: Assisted bathing roll-in shower using exceptions, examples 1 and 2.

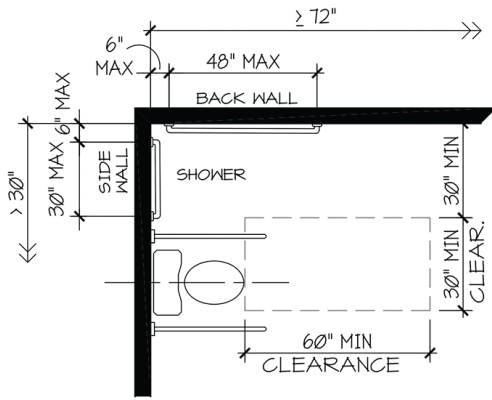

ASSISTED BATHING
ROLL-IN SHOWER -
USING EXCEPTIONS
EXAMPLE 1

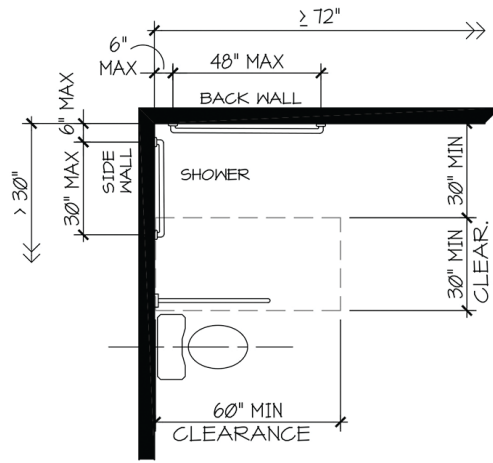

ASSISTED BATHING
ROLL-IN SHOWER -
USING EXCEPTIONS
EXAMPLE 2

It is the opinion of the CHC and others that have reviewed these new options, that this will be viewed as designs that are specific to the needs of the population they serve, and therefore meet or exceed the intent of the Accessible unit options in the ICC A117.1 and the 2010 ADA Standard for Accessible Design.

There is not a concern for the assisted toilet and bathing facilities to be in conflict with the Type B units required in these facilities (IBC Section 1107.5.1.2, 1107.5.2.2), because the provisions addressed in this new option would be permitted under the current requirements for Type B units (ICC A117.1 Section 1004). These provisions provide a higher level of accessibility than required in the Fair Housing Guidelines.

2. Why is the proposed code change a reasonable solution?

See above.

3. What other factors should the TAG consider?

These changes also resolve conflicts between current MN amendments and new Statutes for State Licensed Facilities regulated by the MN Department of Health

Cost/Benefit Analysis

1. Will the proposed code change increase or decrease costs? Please explain and provide estimates if possible.

No cost change. The proposed change is more about how many of the required accessible units will be allowed to comply with alternate accessibility requirements for assisted toileting and bathing environments. The alternate allowances are substantially similar to the requirements for Type B units already required.

2. If there is an increased cost, will this cost be offset by a safety or other benefit? Please explain. If the benefit is quantifiable (for example energy savings), provide an estimate if possible.

N/A

3. If there is a cost increase, who will bear the costs? This can include government units, businesses, and individuals.

N/A

4. Are there any enforcement or compliance cost increases or decreases with the proposed code change? Please explain.

N/A

5. Will the cost of complying with the proposed code change in the first year after the rule takes effect exceed \$25,000 for any one small business or small city ([Minn. Stat. § 14.127](#))? A small business is any business that has less than 50 full-time employees. A small city is any statutory or home rule charter city that has less than ten full-time employees. Please explain.

N/A

Regulatory Analysis

1. What parties or segments of industry are affected by this proposed code change?
[Architects, building code plan reviewers and inspectors, building owners and operators and the MN Department of Health.](#)
2. Can you think of other means or methods to achieve the purpose of the proposed code change? What might someone opposed to this code change suggest instead? Please explain what the alternatives are and why your proposed change is the preferred method or means to achieve the desired result.
[No known alternatives or alternate suggestions.](#)
3. What are the probable costs or consequences of not adopting the code change, including those costs or consequences borne by identifiable categories of affected parties, such as separate classes of government units, businesses, or individuals?
[Probable costs of not adopting the code change is that people needing assisted toileting and bathing facilities will not have access to dwelling units with these essential features.](#)
4. Are you aware of any federal or state regulation or requirement related to this proposed code change? If so, please list the federal or state regulation or requirement and your assessment of any differences between the proposed code change and the federal regulation or requirement.
[The Federal ADA, under the 2010 ADA Standards requires 50% of the resident sleeping units in I-2 nursing homes to be fully accessible, rather than the 10% Accessible plus 90 percent assisted being proposed in this draft change. Based on the research noted above, these new options will be viewed as designs that are specific to the needs of the population they serve, and therefore meet or exceed the intent of the Accessible unit options in the ICC A117.1 and the 2010 ADA Standard for Accessible Design.](#)

***Note: Incomplete forms may be returned to the submitter with instruction to complete the form. Only completed forms can considered by the TAG.



CODE CHANGE PROPOSAL FORM

(Must be submitted electronically)

Author/requestor: C. Scott Anderson

Date: 5/06/24

Email address: c.scott.anderson@minneapolismn.gov

Model Code: 2024 IBC

Telephone number: 612-246-7303

Code or Rule Section: 1341

Firm/Association affiliation, if any: City of Minneapolis

Topic of proposal: 1103.2.11 Residential Group R-1 + R-3

Code or rule section to be changed: 1341

Intended for Technical Advisory Group ("TAG"):

General Information

Yes **No**

- | | | |
|--|-------------------------------------|-------------------------------------|
| A. Is the proposed change unique to the State of Minnesota? | <input type="checkbox"/> | <input checked="" type="checkbox"/> |
| B. Is the proposed change required due to climatic conditions of Minnesota? | <input type="checkbox"/> | <input checked="" type="checkbox"/> |
| C. Will the proposed change encourage more uniform enforcement? | <input checked="" type="checkbox"/> | <input type="checkbox"/> |
| D. Will the proposed change remedy a problem? | <input checked="" type="checkbox"/> | <input type="checkbox"/> |
| E. Does the proposal delete a current Minnesota Rule, chapter amendment? | <input type="checkbox"/> | <input checked="" type="checkbox"/> |
| F. Would this proposed change be appropriate through the ICC code development process? | <input checked="" type="checkbox"/> | <input type="checkbox"/> |

Proposed Language

1. The proposed code change is meant to:

- change language contained the model code book? If so, list section(s).
- change language contained in an existing amendment in Minnesota Rule? If so, list Rule part(s).
- delete language contained in the model code book? If so, list section(s).
- delete language contained in an existing amendment in Minnesota Rule? If so, list Rule part(s).
- add new language that is not found in the model code book or in Minnesota Rule.
1103.2.11 Residential Group R-1 + R-3

2. Is this proposed code change required by Minnesota Statute? If so, please provide the citation.

No

3. Provide *specific* language you would like to see changed. Indicate proposed new words with underlining and ~~striketrough~~ words proposed for deletion. Include the entire code (sub) section or rule subpart that contains your proposed changes.

1103.2.11 Residential Group R-1 or R-3. ~~Buildings of Group R-1 containing not more than five dwelling units and sleeping units in aggregate for rent or hire that are also occupied as the residence of the proprietor and that contain not more than five~~ questrooms for rent or hire are not required to comply with this chapter. ~~Buildings of Group R-3 congregate living facilities (transient) or boarding houses (transient) containing not more than five sleeping units for rent or hire that are also occupied as the residence of the proprietor and that contain not more than five~~ questrooms for rent or hire are not required to comply with this chapter

4. Will this proposed code change impact other sections of a model code book or an amendment in Minnesota Rule? If so, please list the affected sections or rule parts.

NO

Need and Reason

1. Why is the proposed code change needed? Please provide a general explanation as well as a specific explanation for any changes to numerical values (heights, area, etc.)

This is intended to exempt small bed-n-breakfast facilities where the owner lives (possible dwelling unit) in the same building and there are only 5 guestrooms (sleeping units). By saying 'aggregate' this could be read to add the owner's living quarters to the count. This exception is not intended to extend to small transient apartment buildings that offer units for rent, even if the owner lived in the building. Since the IBC includes a definition for 'guestroom', it is clearer to just go back to that language for this specific section. It is also a consistent use of terms as found in Section 310.4.

2. Why is the proposed code change a reasonable solution?

This addition to the definition reduced confusion and clarifies code requirement

3. What other factors should the TAG consider?

None

Cost/Benefit Analysis

1. Will the proposed code change increase or decrease costs? Please explain and provide estimates if possible.

This is an editorial change and should not impact the cost of construction.

2. If there is an increased cost, will this cost be offset by a safety or other benefit? Please explain. If the benefit is quantifiable (for example energy savings), provide an estimate if possible.

No cost change

3. If there is a cost increase, who will bear the costs? This can include government units, businesses, and individuals.

NA

4. Are there any enforcement or compliance cost increases or decreases with the proposed code change? Please explain.
No
5. Will the cost of complying with the proposed code change in the first year after the rule takes effect exceed \$25,000 for any one small business or small city ([Minn. Stat. § 14.127](#))? A small business is any business that has less than 50 full-time employees. A small city is any statutory or home rule charter city that has less than ten full-time employees. Please explain.
No

Regulatory Analysis

1. What parties or segments of industry are affected by this proposed code change?
Architects, Contractors, Developers, Building Owners, Contractors, Building Officials
2. Can you think of other means or methods to achieve the purpose of the proposed code change? What might someone opposed to this code change suggest instead? Please explain what the alternatives are and why your proposed change is the preferred method or means to achieve the desired result.
No
3. What are the probable costs or consequences of not adopting the code change, including those costs or consequences borne by identifiable categories of affected parties, such as separate classes of government units, businesses, or individuals?
Not adopting this change will continue the confusion about how accessibility is applied to these small B+B's
4. Are you aware of any federal or state regulation or requirement related to this proposed code change? If so, please list the federal or state regulation or requirement and your assessment of any differences between the proposed code change and the federal regulation or requirement.
This change was adopted by the ICC egress committee at the April 2024 Code Action Hearings by a vote of 14-0 and is unlikely to be overturned at the final action hearings and voting. Regardless of the ICC actions this is a significant improvement to the current code language.

***Note: Incomplete forms may be returned to the submitter with instruction to complete the form. Only completed forms can be considered by the TAG.



CODE CHANGE PROPOSAL FORM

(Must be submitted electronically)

Author/requestor: Karen Gridley

Date: 5/17/2024

Email address: karen.gridley@state.mn.us

Model Code: ANSI A117.1

Telephone number: 651-284-5877

Code or Rule Section: MR 1341.604.3.2.2 and A117.1 604.9.2

Firm/Association affiliation, if any: CCLD Topic of proposal: Toilet Clearance depth & Compartment Size

Code or rule section to be changed: MR 1341.0604 Subpart 1 Section 604.3.2.2, and A117.1 604.9.2

Intended for Technical Advisory Group ("TAG"): 1341

General Information

Yes **No**

- | | | |
|--|-------------------------------------|-------------------------------------|
| A. Is the proposed change unique to the State of Minnesota? | <input checked="" type="checkbox"/> | <input type="checkbox"/> |
| B. Is the proposed change required due to climatic conditions of Minnesota? | <input type="checkbox"/> | <input checked="" type="checkbox"/> |
| C. Will the proposed change encourage more uniform enforcement? | <input checked="" type="checkbox"/> | <input type="checkbox"/> |
| D. Will the proposed change remedy a problem? | <input checked="" type="checkbox"/> | <input type="checkbox"/> |
| E. Does the proposal delete a current Minnesota Rule, chapter amendment? | <input type="checkbox"/> | <input checked="" type="checkbox"/> |
| F. Would this proposed change be appropriate through the ICC code development process? | <input type="checkbox"/> | <input checked="" type="checkbox"/> |

Proposed Language

1. The proposed code change is meant to:

Change language contained the model code book? If so, list section(s).

This would delete some of the model code language and replace a portion with a MN amendment.

change language contained in an existing amendment in Minnesota Rule? If so, list Rule part(s).

This would change 1341 604.9.2 to accept model code 604.9.2. It would also update the figure 604.3 we've added to MN Rule

delete language contained in the model code book? If so, list section(s).

A117.1 Section 604.9.2.1

delete language contained in an existing amendment in Minnesota Rule? If so, list Rule part(s).

add new language that is not found in the model code book or in Minnesota Rule.

2. Is this proposed code change required by Minnesota Statute? If so, please provide the citation.

No.

3. Provide *specific* language you would like to see changed. Indicate proposed new words with underlining and ~~striethrough~~ words proposed for deletion. Include the entire code (sub) section or rule subpart that contains your proposed changes.

(Note: Purple = proposed MN amendment. Black– model code language. Red = proposed deleted model language)

MN Rule 1341.0604 Subpart 1 Section 604.3.2.2 water closet clearance.

604.3 Clearance. (Carry forward MN 1341 language for 604.3.2 – 604.3.3)

Replace the MN Figure 604.3 with the modification shown below which used improved A117.1 figure, but with MN rule dimensions.

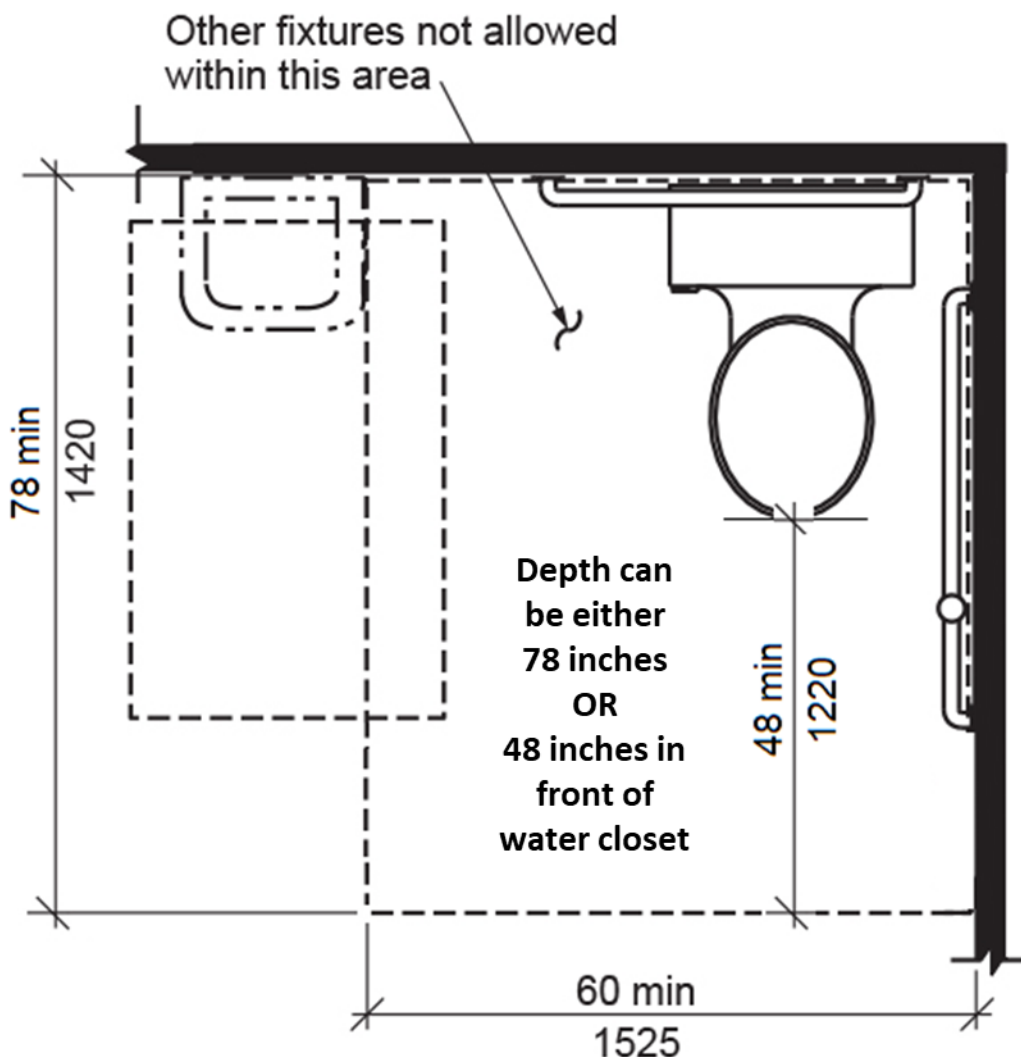

**FIGURE 604.3
SIZE OF CLEARANCE FOR WATER CLOSET**

A117.1 Section 604.9.2, and, MN Rule 1341.0604 Subpart 4 Section 604.9.2 wheelchair accessible compartment.

604.9.2 Size.

Wheelchair accessible toilet compartments shall comply with Section 604.9.2.1, 604.9.2.2 or 604.9.2.3 as applicable.

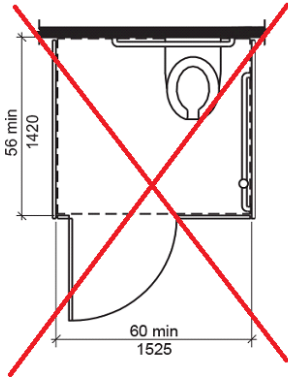

FIGURE 604.9.2(A)

~~WHEELCHAIR TOILET COMPARTMENTS WALL HUNG CLOSET, ADULT~~

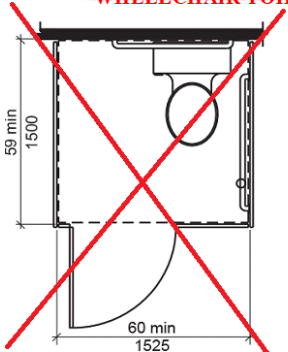

FIGURE 604.9.2(B)

~~WHEELCHAIR TOILET COMPARTMENTS FLOOR MOUNTED WATER CLOSET, ADULT—WALL HUNG AND FLOOR MOUNTED WATER CLOSET, CHILDREN~~

604.9.2.1-Minimum area with out-swinging compartment door. The minimum area of a wheelchair accessible toilet compartment with an out-swinging door shall be 60 inches (1525 mm) minimum in width measured perpendicular to the side wall, and either 78 inches minimum from the back wall or 48 inches minimum in front of the water closet ~~minimum in depth for wall hung water closets, and 59 inches (1500 mm) minimum in depth for floor mounted water closets measured perpendicular to the rear wall.~~

604.9.2.2 Compartment for children's use.

The minimum area of a wheelchair accessible toilet compartment primarily for children's use shall be 60 inches (1525 mm) minimum in width measured perpendicular to the side wall, and 59 inches (1500 mm) minimum in depth for wall hung and floor mounted water closets measured perpendicular to the rear wall.

604.9.2.3 Alternate wheelchair accessible toilet compartments.

Where an alternate wheelchair accessible toilet compartment is provided the minimum area of the compartment shall be 60 inches (1525 mm) minimum in width, measured perpendicular to the side wall, and 84 inches (2135 mm) minimum in depth, measured perpendicular to the rear wall.

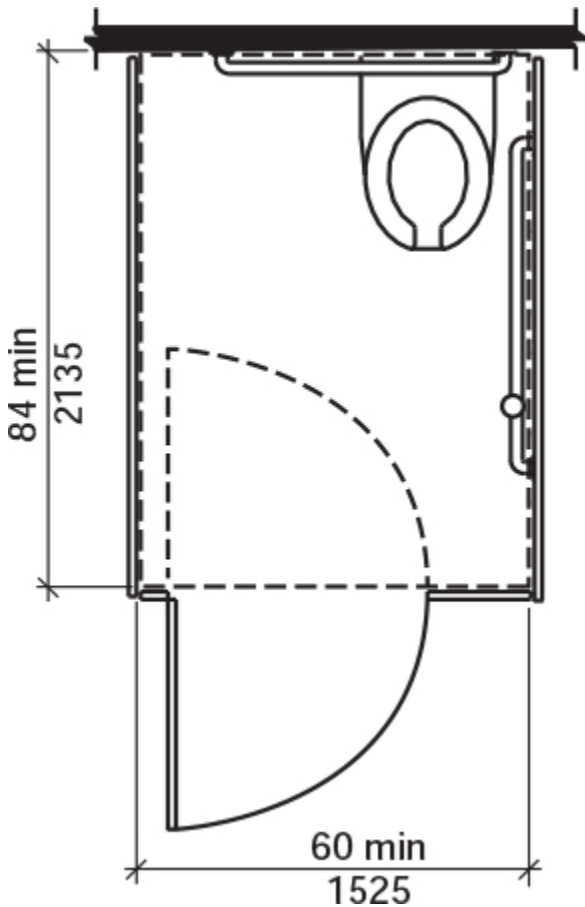

FIGURE 604.9.2.3
WHEELCHAIR TOILET COMPARTMENTS ALTERNATE WHEELCHAIR TOILET
COMPARTMENT

604.9.3 Doors.

Wheelchair accessible toilet compartment doors, including door hardware, shall comply with Section 404. The door shall be self-closing. A door pull complying with Section 404.2.6 shall be placed on both sides of the door near the latch. Wheelchair accessible toilet compartment doors shall not swing into the required minimum area of the compartment.

Exceptions:

1. Outside of the compartment, where the approach is to the latch side of the wheelchair accessible toilet compartment, door clearance between the door side of the compartment and any obstruction shall be 42 inches (1065 mm) minimum.
2. Within the wheelchair accessible toilet compartment, maneuvering clearances at the door shall not be required to comply with Section 404.
3. In an alternate wheelchair accessible toilet compartment, the door shall be permitted to swing into the stall where a clear floor space complying with Section 305.3 is provided within the stall beyond the arc of the door swing.

Door shall not swing into the required minimum area of the compartment.

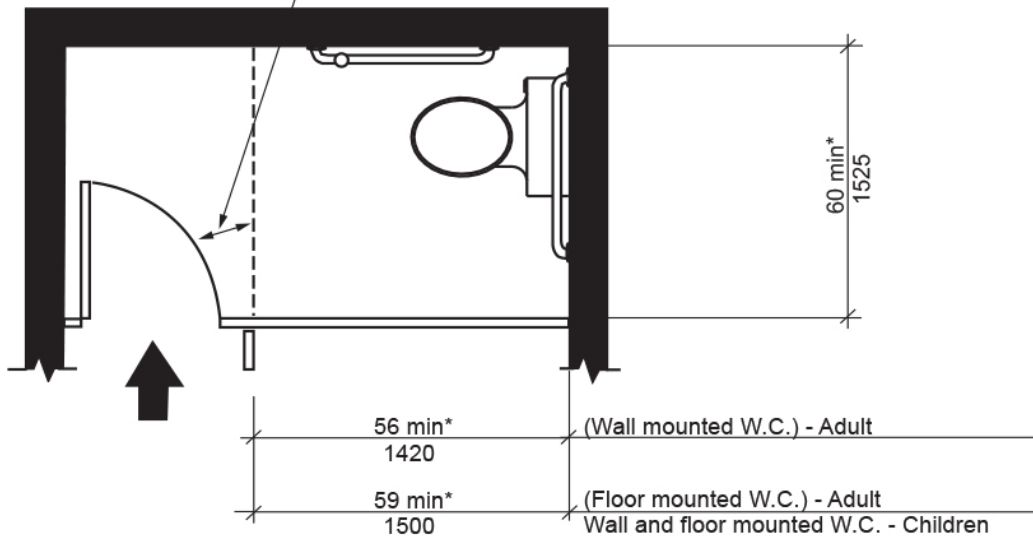

* Toilet compartment size per Sections 604.9.2.1 and 604.9.2.2
 * Toilet compartment size per Sections 604.9.2.1 and 604.9.2.2

FIGURE 604.9.3(A)
WHEELCHAIR TOILET COMPARTMENT DOORS DOOR SWINGING INTO THE WHEELCHAIR TOILET COMPARTMENT

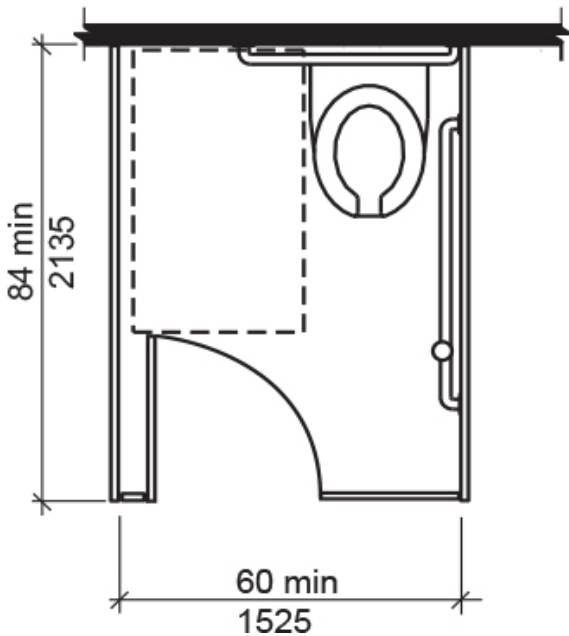

* Toilet compartment size per Section 604.9.2.3

FIGURE 604.9.3(B)
WHEELCHAIR TOILET COMPARTMENT DOORS EXCEPTION 3 - ALTERNATE WHEELCHAIR COMPARTMENT

4. Will this proposed code change impact other sections of a model code book or an amendment in Minnesota Rule? If so, please list the affected sections or rule parts.

No

Need and Reason

1. Why is the proposed code change needed? Please provide a general explanation as well as a specific explanation for any changes to numerical values (heights, area, etc.)
This change is required in order to align with the Minnesota amendments for a deeper clearance at wheelchair accessible water closets which impacts the minimum clearance within a wheelchair-accessible toilet compartment. It clarifies that the compartment door must swing out in order to provide a compartment that is the same size as the wheelchair clearance. If the door swings into the compartment it must be deeper (84" minimum deep) per the alternate compartment size in Section 604.9.2.3. The door is allowed to swing into alternate sized compartments if there is a 30" x 52" clear floor space within the compartment beyond the door swing per Exception 3 under 604.9.3 for doors.
2. Why is the proposed code change a reasonable solution?
To align with the MN 1341 amendment.
3. What other factors should the TAG consider?
That toe clearance requirements and door location requirements will now be more important to maintain with the new larger clear floor space and turning space sizes.

Cost/Benefit Analysis

1. Will the proposed code change increase or decrease costs? Please explain and provide estimates if possible.
No. The language clarifies an existing MN amendment and clarifies the size requirements for alternate wheelchair-accessible compartments.
2. If there is an increased cost, will this cost be offset by a safety or other benefit? Please explain. If the benefit is quantifiable (for example energy savings), provide an estimate if possible.
N/A
3. If there is a cost increase, who will bear the costs? This can include government units, businesses, and individuals.
N/A.
4. Are there any enforcement or compliance cost increases or decreases with the proposed code change? Please explain.
N/A
5. Will the cost of complying with the proposed code change in the first year after the rule takes effect exceed \$25,000 for any one small business or small city ([Minn. Stat. § 14.127](#))? A small business is any business that has less than 50 full-time employees. A small city is any statutory or home rule charter city that has less than ten full-time employees. Please explain.

No.

Regulatory Analysis

1. What parties or segments of industry are affected by this proposed code change?

Architects, designers, property owners and businesses.

2. Can you think of other means or methods to achieve the purpose of the proposed code change? What might someone opposed to this code change suggest instead? Please explain what the alternatives are and why your proposed change is the preferred method or means to achieve the desired result.

No

3. What are the probable costs or consequences of not adopting the code change, including those costs or consequences borne by identifiable categories of affected parties, such as separate classes of government units, businesses, or individuals?

The consequence of not making this change would result in inconsistency and non-compliance in the compartment size of wheelchair-accessible compartments.

4. Are you aware of any federal or state regulation or requirement related to this proposed code change? If so, please list the federal or state regulation or requirement and your assessment of any differences between the proposed code change and the federal regulation or requirement.

No

***Note: Incomplete forms may be returned to the submitter with instruction to complete the form. Only completed forms can be considered by the TAG.



CODE CHANGE PROPOSAL FORM

(Must be submitted electronically)

Author/requestor: Karen Gridley

Date: 6/20/2024

Email address: karen.gridley@state.mn.us

Model Code: A117.1

Telephone number: 652-284-5877

Code or Rule Section: 802.1

Firm/Association affiliation, if any: CCLD

Topic of proposal: Assembly Seating w/ Dining or Work Surfaces.

Code or rule section to be changed: A117.1 Section 802.1

Intended for Technical Advisory Group ("TAG"): 1341

General Information

Yes No

- | | | |
|--|-------------------------------------|-------------------------------------|
| A. Is the proposed change unique to the State of Minnesota? | <input checked="" type="checkbox"/> | <input type="checkbox"/> |
| B. Is the proposed change required due to climatic conditions of Minnesota? | <input type="checkbox"/> | <input checked="" type="checkbox"/> |
| C. Will the proposed change encourage more uniform enforcement? | <input checked="" type="checkbox"/> | <input type="checkbox"/> |
| D. Will the proposed change remedy a problem? | <input checked="" type="checkbox"/> | <input type="checkbox"/> |
| E. Does the proposal delete a current Minnesota Rule, chapter amendment? | <input type="checkbox"/> | <input checked="" type="checkbox"/> |
| F. Would this proposed change be appropriate through the ICC code development process? | <input type="checkbox"/> | <input checked="" type="checkbox"/> |

Proposed Language

1. The proposed code change is meant to:

- change language contained the model code book? If so, list section(s).
- change language contained in an existing amendment in Minnesota Rule? If so, list Rule part(s).
- delete language contained in the model code book? If so, list section(s).
- delete language contained in an existing amendment in Minnesota Rule? If so, list Rule part(s).
- add new language that is not found in the model code book or in Minnesota Rule.
Yes. Adds new language not found in the A117.1.

2. Is this proposed code change required by Minnesota Statute? If so, please provide the citation.

No

3. Provide *specific* language you would like to see changed. Indicate proposed new words with underlining and ~~striketrough~~ words proposed for deletion. Include the entire code (sub) section or rule subpart that contains your proposed changes.

802.1 General.

Wheelchair spaces and wheelchair space locations in assembly areas with spectator seating shall comply with Section 802. Where tiered seating **required to be accessible by Chapter 11 of the International Building Code** includes dining surfaces or work surfaces, wheelchair spaces and wheelchair space locations shall comply with Section 802.6, 802.7, 802.9, 802.10 and 902. Team and player seating shall comply with Sections 802.2 through 802.7.

(**note:** Green text = new model code language. Blue = proposed new 1341 language.)

4. Will this proposed code change impact other sections of a model code book or an amendment in Minnesota Rule? If so, please list the affected sections or rule parts.

No.

Need and Reason

1. Why is the proposed code change needed? Please provide a general explanation as well as a specific explanation for any changes to numerical values (heights, area, etc.)

This proposed code change is necessary because the language as written in the 2017 A117.1 is scoping language that conflicts with the scoping requirements of IBC Chapter 11. It is necessary to qualify the new language with a reference back to the scoping of IBC Chapter 11. Scoping for tiered seating and assembly seating is covered in 1341 Scoping Section 1104.4, 1108.2.4 and 1108.2.9 for where an accessible route and wheelchair seating is required to be provided to tiered assembly seating areas.

2. Why is the proposed code change a reasonable solution?
The proposed change is reasonable in order to remove conflicting scoping language.

3. What other factors should the TAG consider?

None.

Cost/Benefit Analysis

1. Will the proposed code change increase or decrease costs? Please explain and provide estimates if possible.

No cost change. The proposed change clarifies the intent of the code to provide accessible wheelchair seating areas within assembly and tiered seating areas.

2. If there is an increased cost, will this cost be offset by a safety or other benefit? Please explain. If the benefit is quantifiable (for example energy savings), provide an estimate if possible.

N/A

3. If there is a cost increase, who will bear the costs? This can include government units, businesses, and individuals.

N/A

4. Are there any enforcement or compliance cost increases or decreases with the proposed code change? Please explain.

N/A

5. Will the cost of complying with the proposed code change in the first year after the rule takes effect exceed \$25,000 for any one small business or small city ([Minn. Stat. § 14.127](#))? A small business is any business that has less than 50 full-time employees. A small city is any statutory or home rule charter city that has less than ten full-time employees. Please explain.

N/A

Regulatory Analysis

1. What parties or segments of industry are affected by this proposed code change?

Building owners, architects, designers, code officials and inspectors.

2. Can you think of other means or methods to achieve the purpose of the proposed code change? What might someone opposed to this code change suggest instead? Please explain what the alternatives are and why your proposed change is the preferred method or means to achieve the desired result.

No

3. What are the probable costs or consequences of not adopting the code change, including those costs or consequences borne by identifiable categories of affected parties, such as separate classes of government units, businesses, or individuals?

The consequence of not adopting the code change is inconsistent enforcement due to misinterpretation of the language.

4. Are you aware of any federal or state regulation or requirement related to this proposed code change? If so, please list the federal or state regulation or requirement and your assessment of any differences between the proposed code change and the federal regulation or requirement.

IBC Chapter 11 sections mentioned above.

***Note: Incomplete forms may be returned to the submitter with instruction to complete the form. Only completed forms can be considered by the TAG.